

# HOME OWNER PLUMBING AND HEATING GUIDE



*Where quality lives*

David Wilson Homes

**Renelec**  
CHALGROVE

Renelec Chalgrove Limited  
Unit 43  
Monument Business Park  
Chalgrove  
Oxfordshire  
OX44 7RW

1.	<b>INTRODUCTION</b> .....	2
2.	<b>HOW TO IDENTIFY YOUR SYSTEM</b> .....	3
I.	The modern domestic heating system .....	3
II.	Types of system .....	4
a)	Gravity.....	4
b)	Mains Pressure .....	4
c)	Renewable heating .....	6
3.	<b>IDENTIFYING KEY COMPONENTS IN THE SYSTEM</b> .....	8
a)	Location of underground shut off valve.....	8
b)	Location of the main water stopcock .....	8
c)	External Tap isolation Valve .....	8
d)	Double Check valve/Non Return Valve (NRV).....	8
e)	Basin isolation valve .....	9
f)	Roof tank isolation valve (gravity system only).....	9
g)	Balancing .....	9
h)	Heating Filling loop .....	9
i)	Pressure gauge.....	9
j)	Auto-bypass valve.....	10
k)	W.C. Isolation valves .....	10
l)	Isolation valve.....	10
m)	Cold Mains water Isolation valve.....	10
n)	Central Heating Pump .....	11
o)	Hot water secondary return pump.....	11
p)	Zone Valves .....	11
q)	Expansion Vessel.....	12
r)	Tundish .....	12
s)	Pressure reducing/Balancing valve.....	12
t)	Accumulator / water Booster .....	13
4.	<b>GAS</b> .....	14
a)	Gas in your property .....	14
b)	Gas Safe Register .....	14
c)	Flues & Chimneys.....	15
d)	Gas Safety Certificates.....	15
e)	Gas Certificates .....	15
f)	Do you live in a rented property? .....	15
g)	Are you a landlord?.....	15
j)	Are you a homeowner?.....	16
5.	<b>DRAINAGE</b> .....	17
6.	<b>GETTING THE BEST FROM YOUR SYSTEM</b> .....	19
a)	Types of heating system .....	19
b)	Low or high temperature central heating?.....	19
c)	Controls.....	19
d)	Operating your heating .....	21
e)	Operating your hot water .....	22
f)	Operating underfloor heating. ....	22
g)	Operating solar hot water. ....	23
7.	<b>SERVICING AND MAINTENANCE</b> .....	25
a)	Boiler service.....	25
b)	Unvented hot water system.....	26
c)	Solar .....	27
8.	<b>COMMON CENTRAL HEATING AND HOT WATER ISSUES</b> .....	28
b)	Why is Discharge overflow is leaking outside and dripping water in airing cupboard .....	28
c)	Why is the expansion vessel failing .....	28
d)	Why is my system pressure low?.....	28
e)	How do I increase system pressure? .....	30
f)	My boiler is not working?.....	31
g)	There is only hot water or heating not both?.....	32
9.	<b>WARRANTY</b> .....	33
10.	<b>WARRANTY EMERGENCY CALLOUT (2 YEAR NHBC COVER)</b> .....	34
11.	<b>Frequently asked questions</b> .....	35
12.	<b>Disclaimer</b> .....	40

## 1. INTRODUCTION

This Home owner's guide has been written to aid you into better understanding of the operation, components, usage and general maintenance of your plumbing and heating system in your new home, in the hope that being furnished with this information, will aid you in getting the best from your system and prolong the life span.

Whilst we realise you have your new home and there is a lot to take in, we recommend you take the time to know at least what you should do in the event of

- no heating or hot water,
- how to pressurize your system and
- isolate your water

These are considered key points you should be aware of and they are all explained in this homeowners guide because when you have no heating or hot water, you can apply these simple steps to remedy the situation and mitigate your inconvenience and loss.

Also in this pack we cover Boiler, cylinder, solar servicing and maintenance, so you can understand the need to service on a yearly basis and what it entails. Manufacturers will NOT warranty any products without proof of servicing after 12 months.

Any information and or advice in this pack is purely generic and although we have tried to make it all encompassing this guide should always be read in conjunction with the manufacturer's user guides and instructions, as these may differ may differ.

## CONTACT DETAILS



Renelec Chalgrove Limited  
Unit 43  
Monument Business Park  
Chalgrove  
Oxfordshire  
OX44 7RW

Tel : 01865 891955  
Fax : 01865 891950  
Email: [mail@renelec-chalgrove.co.uk](mailto:mail@renelec-chalgrove.co.uk)

## 2. HOW TO IDENTIFY YOUR SYSTEM

We install numerous types of plumbing and heating systems in a vast array of property types from a one bed flat to a six bedroom house.

### I. The modern domestic heating system

In general the modern heating system consists of the following components, however there are deviations from this which are highlighted and covered further in detail in later sections of this document:

- 1) **Boiler:** - It has two functions
  - a) Heat the hot water
  - b) Provide heat to the property via heating the radiators or Underfloor heating
- 2) **Programmer:** - Tells the boiler the preselected times when to heat the heating and the hot water
- 3) **Room thermostat:** - controls the temperature of the house, and tell the boiler to turn off when up to temperature.
- 4) **Hot water thermostat:** - tells the boiler to turn off when the hot water is at the required temperature.
- 5) **Radiators / Underfloor heating:** - Transfer the heat from the boiler into the room.
- 6) **Hot water cylinder:** - Transfer the heat from the boiler to the hot water, through a coil in the cylinder
- 7) **Pump:** - Pumps the water round the system to the radiators and the hot water cylinder.
- 8) **Zone Valves:** - Are valves which open and close when the thermostat tells them heat is required so the water can be pumped round the hot water circuit and the Heating circuit.

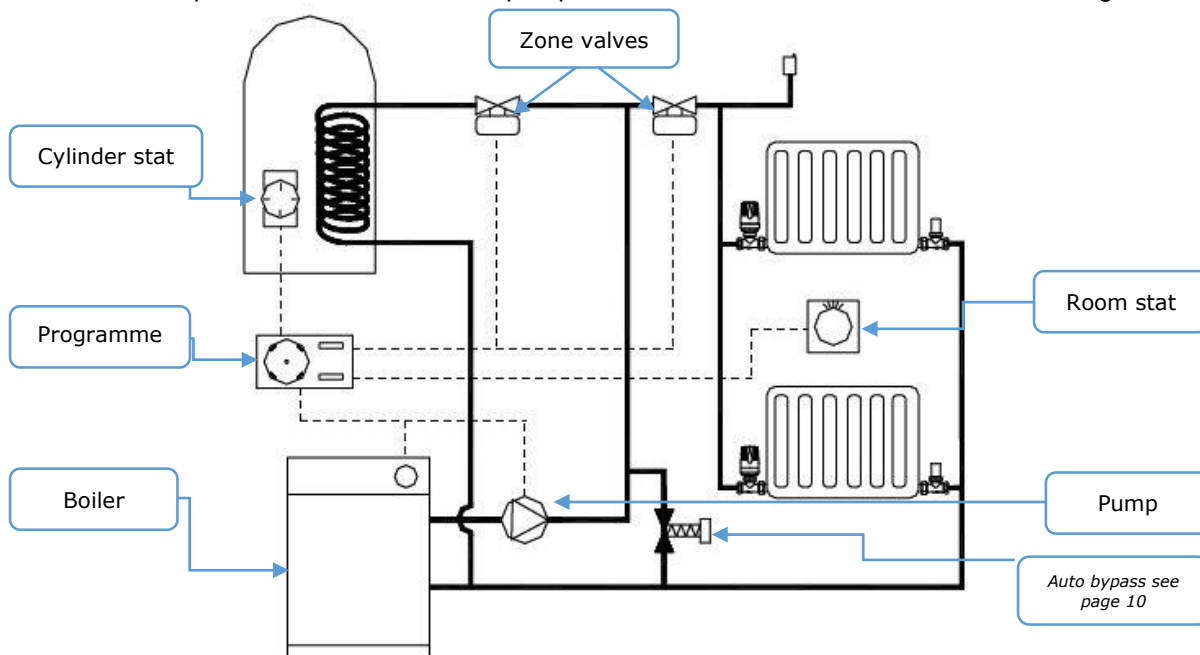

II. Types of system

a) Gravity

Traditional water systems in the UK are called "gravity" systems, where the water from the mains is fed into tanks in the roof and then fed into the boiler, hot water cylinder and plumbing system using no more pressure than the force of gravity. These systems are also called "vented".

If you heat water it expands. In an open vented central heating system (with a header tank) some of the water moves back up into the header tank. The expansion does not increase the overall volume of water by a huge amount (maybe 2 to 4 litres, depending on the size of the heating system) but it would be more than enough to burst the pipes if it had nowhere to go.

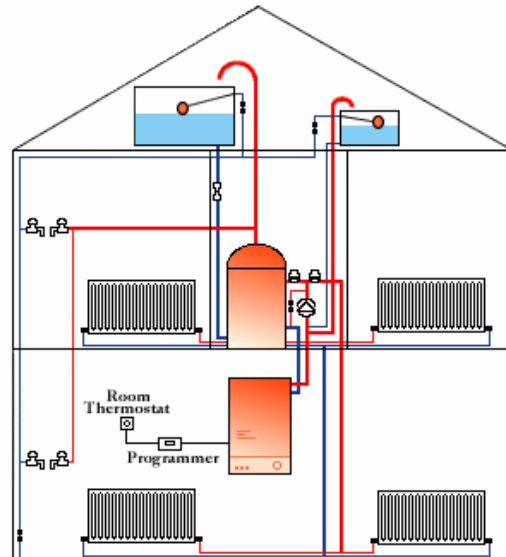

As an installer we are finding that these now tend to be an exception rather than the rule.

b) Mains Pressure

Over recent years, high pressure systems have been introduced. These keep the whole of the hot and cold water systems under constant mains pressure and are "sealed" to the atmosphere.

An un-vented, sealed or pressurized system uses an expansion vessel, containing a diaphragm and a compressible gas (normally oxygen). The expansion in the water as it is heated is accommodated by the gas being compressed. When the system is heated up the water expands and this expansion is accommodated by pushing the diaphragm and compressing the air pocket. The pressure gauge on the boiler or on the pipework will go up to reflect this expansion.

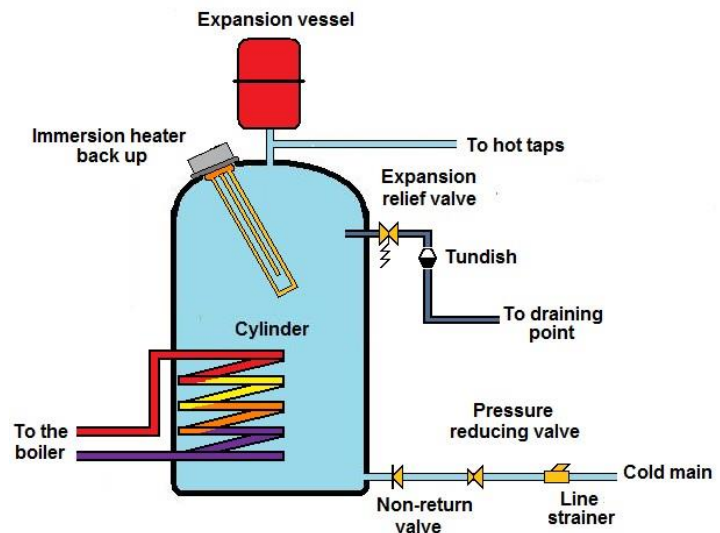

The main benefits are the lack of a requirement for a filling and expansion tank in the loft, no possibility of "pumping over" and also less corrosion and sludge build up.

This type of system can be achieved by several methods explained overleaf.

1) Sealed System such as Megaflo or Tribune.

This system operates with a conventional boiler and a special unvented hot water cylinder designed to store hot water at mains pressure (currently the most common system we install). This consists of an expansion vessel for the heating (red vessel) and an expansion for hot water (either accommodated within the cylinder or a separate white expansion vessel).

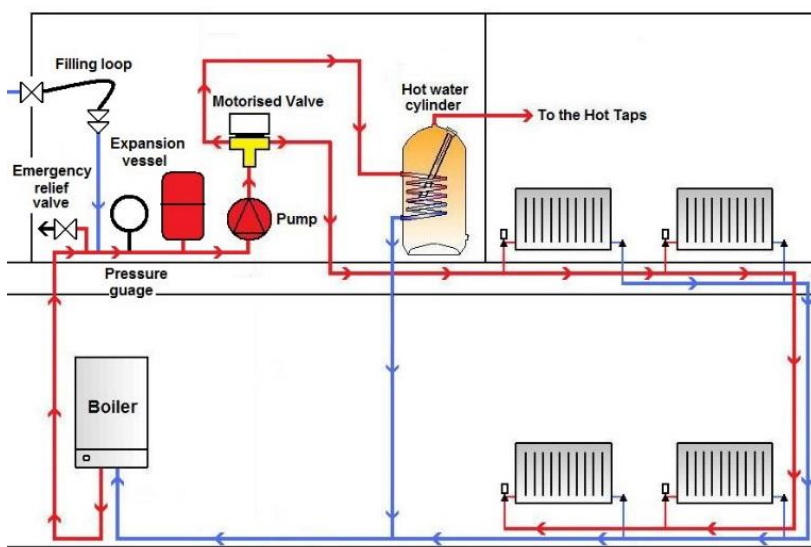

2) System boiler

A system boiler is just like a regular boiler which heats a cylinder for the stored hot water and the radiators for the heating. However, a system boiler differs from a regular boiler in some important respects.

Firstly, many of the major individual components of the heating and hot water system are built into a system boiler, which means that installation is quicker and easier.

Secondly, the hot water is pumped from the system boiler through the heating system to the radiators and hot water cylinder, rather than on a conventional sealed system the pump is in the airing cupboard, so the heat from the boiler is pumped to the airing cupboard and then distributed around the house.

1) A Combination boiler

A Combination boiler provides a continuous but limited flow of pressurised hot water on demand, when you open a tap and the flow of water through the boiler tells it to heat the water so you have instant hot water, with no stored water in the system, hence no requirement for a cylinder.

Combination boilers are normally installed in flats and 1 bathroom houses. It is possible to install on larger properties but the boiler has to be correctly chosen to attain the required flow of hot water for the greater demand.

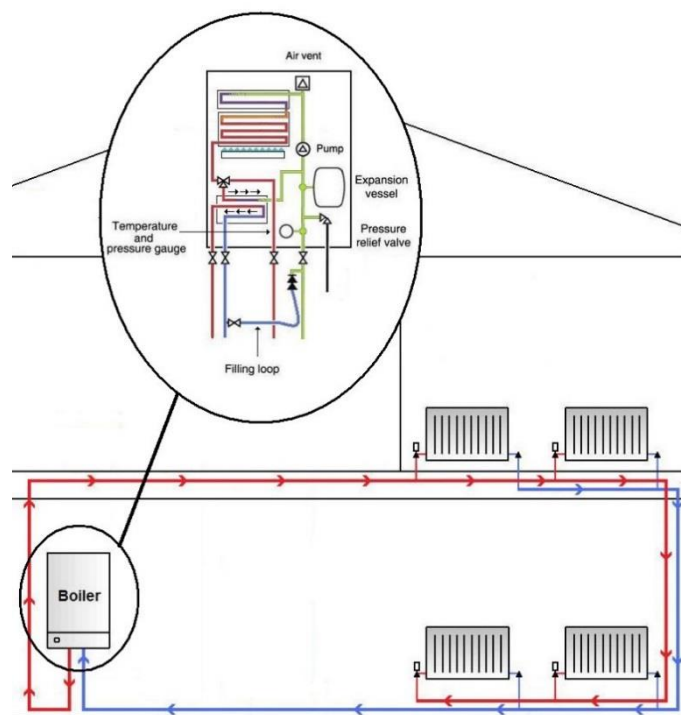

2) Direct Cylinders

Direct cylinders were originally designed to be used in conjunction with solid fuel appliances and back boilers. Today these units more commonly use electric immersion heaters as their heat source often taking the benefit of the Electricity Companies' lower rate Economy 7 tariffs.

We tend to only install these units in flats, where there is no gas supply and the heating is done via electric panel heaters or electric underfloor heating.

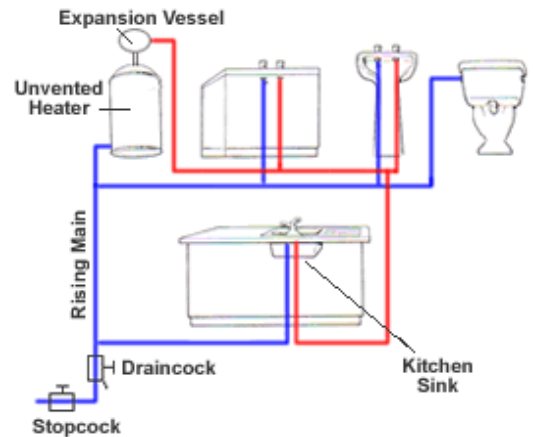

c) Renewable heating

1) Solar Hot water

Solar water heating systems use solar panels, fitted to your roof. These collect heat from the sun and use it to warm water which is stored in a hot water cylinder.

The systems we install tend to be a sealed system with the solar panels connected, via a specialist cylinder which has two coils, one for the boiler and one for the solar.

Solar should provide (depending on sun radiation) over half the hot water requirements throughout the year.

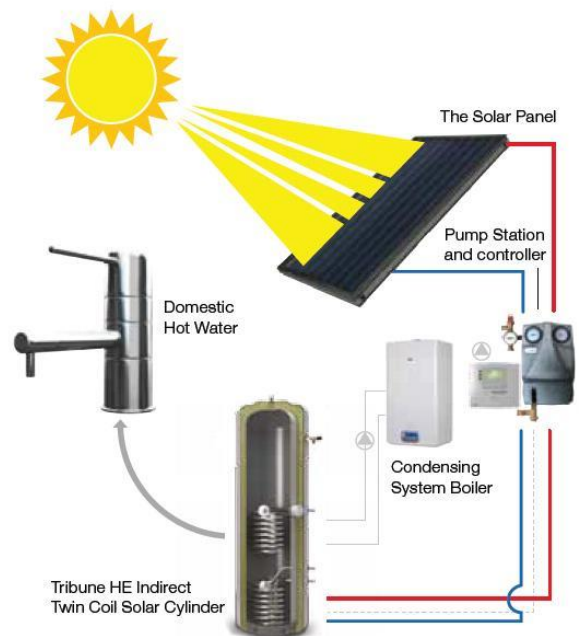

2) Air Source Heat pumps

Air source heat pumps can offer significantly higher levels of efficiency when compared to traditional methods of heating our homes. The unit operates on the opposite principal to a fridge, whereby it takes the cold air from outside, and converts it to heat.

The air source heat pump system is fitted to your outside wall. It harvests renewable, low grade energy from the outdoor air and upgrades this into useful heat to supply a home with hot water and heating.

For every 1kW of electricity, you should get at least 3kW of heating energy.

It can work efficiently all year round even if the outdoor temperature should drop to -15°C.

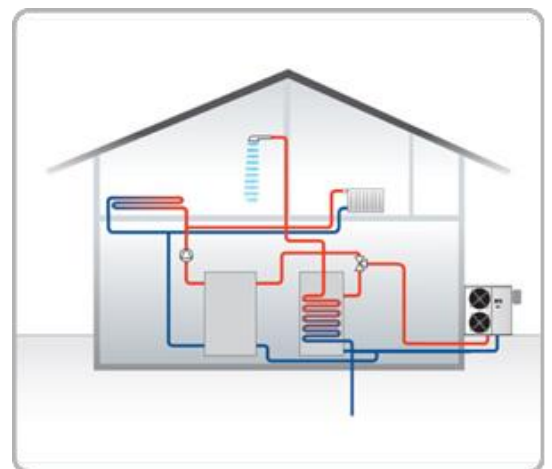

d. Heat Interface unit (HIU)

Requirements for low carbon energy solutions for homes have prompted a rethink on how heating and hot water needs are serviced in the UK residential market – leading to a growing demand for heat interface units.

Multi-dwelling development schemes historically have incorporated individual heating plant into each dwelling as the norm, typically in the form of a combination boiler or direct electric heating system with hot water storage.

An HIU, sometimes referred to as a ‘heat box’, is an integrated solution for delivering and recording the heat consumed by an individual dwelling served from a centralised heating plant or district heating scheme. HIUs provide localised control and metering in a self-contained package, allowing simple integration of individual dwellings into a larger heating and hot water system.

These units can be installed either internally within each dwelling, or recessed into the dividing wall between dwelling and landlord space, allowing ease of access for inspection and maintenance.

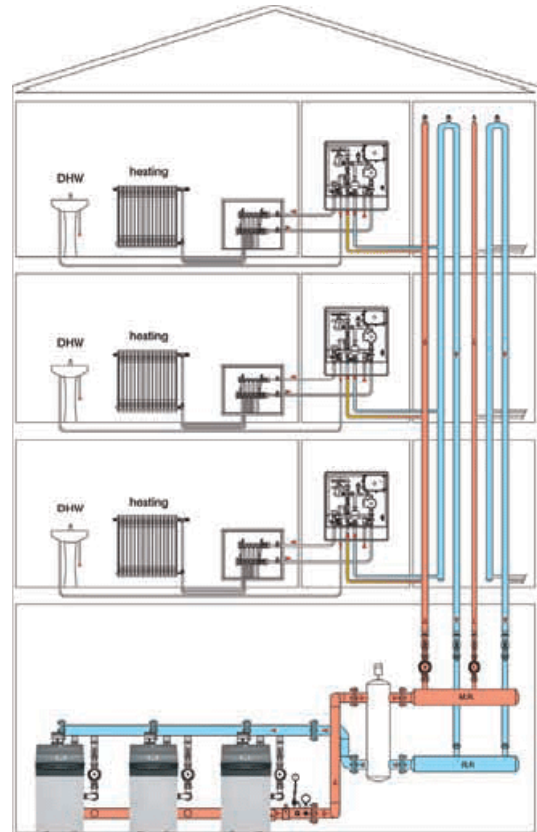



### 3. IDENTIFYING KEY COMPONENTS IN THE SYSTEM.

In your new property you should take the time to familiarise the plumbing and heating system and be aware of the following

a) Location of underground shut off valve

It is a good idea to locate your underground shut off valve, this is where the incoming main can be isolated before the water reaches your Property.



The water supply shut off valve is usually located on the pavement or road, in-line with your stopcock in the house. The valve maybe hard to see, as it could be covered in mud or stones. If you live in a flat the isolation will be in the riser cupboard on your floor and also an additional valve above your front door in the ceiling.

b) Location of the main water stopcock

The stopcock is used to control the flow of water and more importantly, used to shut off the entire supply in an emergency. Once you have found the stopcock it would be a good idea to test it, as overtime it may have become jammed. Use some WD-40 and check that the valve opens and closes freely, and above all make sure that the valve does actually stop the water supply. Always leave the stopcock a ¼ turn from fully open so that you have leverage if it seizes.

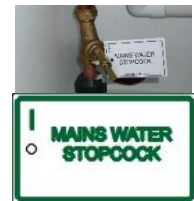

**Location:** Kitchen/Utility sink or where mains supply enters Property  
**Valve type:** Stop Cock

**Description:** Closing this valve will isolate all water in the property. Some hot and cold taps will still run for a short time due to water being stored in the roof tank or if a sealed system in the cylinder.

c) External Tap isolation Valve

**Location:** Kitchen/Utility sink or the airing cupboard if the kitchen is at the front of the property  
**Valve type:** Stop Cock



**Description:** The valve will isolate the outside tap. It is recommended that the valve be closed in the winter months and the OST left open to prevent freezing and damaging the tap. Also in some installations there is a risk that if the pipe work does freeze the NRV (see below) can result in being damaged and leaking.



d) Double Check valve/Non Return Valve (NRV)

**Location:** Kitchen/Utility sink or the airing cupboard  
**Valve type:** Double Check Valve or Non-Return Valve (NRV)



**Description:** This valve is fitted to any external outlet or water draw off point; it stops contaminated water from entering the system and causing infection.

**WARNING: We have found that if the outside tap is not isolated at the internal isolation valve in the winter and the external outside tap left open if the tap does freeze there is a possibility it will leak badly at this point INTERNALLY as this check valve / NRV will stop any expansion in the pipe.**

e) Basin isolation valve

**Location:** Underneath basins  
**Valve type:** Isolation Ballofix valve/Standard isolation valves

**Description:** The basin isolation valves isolate the hot and cold supplies for servicing and maintenance, they require a screw driver to isolate.



f) Roof tank isolation valve (gravity system only)

**Location:** Airing Cupboard  
**Valve type:** Gate valve or stopcock

**Description:** Isolates the cold supply to the water storage tank, feeding the hot & some cold.

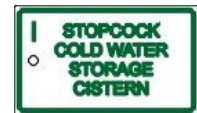

g) Balancing

**Location:** Airing Cupboard  
**Valve type:** Gate valve

**Description:** **Valves should NOT be touched**  
The balancing valve is used to restrict the flow through the hot water cylinder so that the water is slowed going through the coil on the cylinder to allow heat transfer from the boiler to the hot water at its most efficient.



h) Heating Filling loop

**Location:** Airing Cupboard or under kitchen/utility sink  
**Valve type:** Flexible braided hose with a Valve at one or both ends (similar to washing machine valve)

**Description:** Increases water to your heating system increasing the pressure.



i) Pressure gauge

**Location:** Airing Cupboard, under the boiler (Combination boiler and or system boiler) or within boiler case.

**Description:** Shows the pressure within the system. The pressure should be above 1 bar (red dial is just an indicator). Normally where the pressure gauge is also where the filling loop is connected.



j) Auto-bypass valve

**Location:** Airing Cupboard  
**Valve type:** Automatic balancing valve

**Description:** **Valves should NOT be touched**

An Automatic Bypass Valve controls water flow in the Heating Circuit according to the water pressure passing through the valve. Its purpose is to maintain a minimum flow rate through the boiler and to limit circulation pressure when other water paths (zone valves / TRV's) are closed.



The use of Automatic Bypass Valves becomes particularly important when Heating Systems include large numbers of Thermostatic Radiator Valves (TRVs) – whilst the TRVs are open the Automatic Bypass Valve remains closed, however, as the TRVs start to close, the Automatic Bypass Valve starts to open maintaining the required water flow through the boiler.

Using an Automatic Bypass Valve also reduces noise in systems caused by excess water velocities.

Because manual or fixed position valves do not regulate the flow and allow water to bypass even when it is not necessary, Building Regulations require bypass circuits to use Automatic Bypass Valves and no longer permit fixed position valves.

k) W.C. Isolation valves

**Location:** All toilets  
**Valve type:** Service valve



**Description:** Isolates the cold water supply to the W.C. cistern, the centre screw can be turned with a screw driver so the line is at 90 degrees to the pipe to isolate the cistern. Concealed cisterns generally have their isolation valve behind the flush plate.

l) Isolation valve

**Location:** Airing Cupboard  
**Valve type:** Lever valve or stopcock



**Description:** Isolates the cold and hot water. The Hot should isolate all hot taps. The cold should isolate all cold taps except the kitchen sink as fed direct from the incoming main.



m) Cold Mains water Isolation valve

**Location:** Airing Cupboard  
**Valve type:** Lever Valve or stopcock



**Description:** Isolates the cold water supply to the cylinder and thus isolates the hot after the cylinder (although taps may draw off for a short time until the pressure is released from the cylinder).



n) Central Heating Pump

**Location:** In the airing cupboard or internal to the boiler.

**Description:** These pumps are self-regulating and adjust automatically to suit your lifestyle. It pumps the water from the boiler around the cylinder and radiators.



o) Hot water secondary return pump

**Location:** In the airing cupboard.

**Description:** These are installed if you have a hot tap a long way from the cylinder and prevent you having to wait too long for hot water from that point. Many of these are now automated and will work out your usage and times to save running all the time.



p) Zone Valves

**Location:** In the airing cupboard or near the boiler.

**Description:** A zone valve is a specific type of valve used to control the flow of water

1. To the hot water cylinder and opens when the Programmer and cylinder thermostat are calling for hot water to be heated.
2. And the other operates the radiators/underfloor when the Programmer and room stat both call to heat the home. Note: most systems today have two zone valves for the heating, with homes split into zones upstairs/downstairs or the bedrooms are zoned separate to the living rooms.

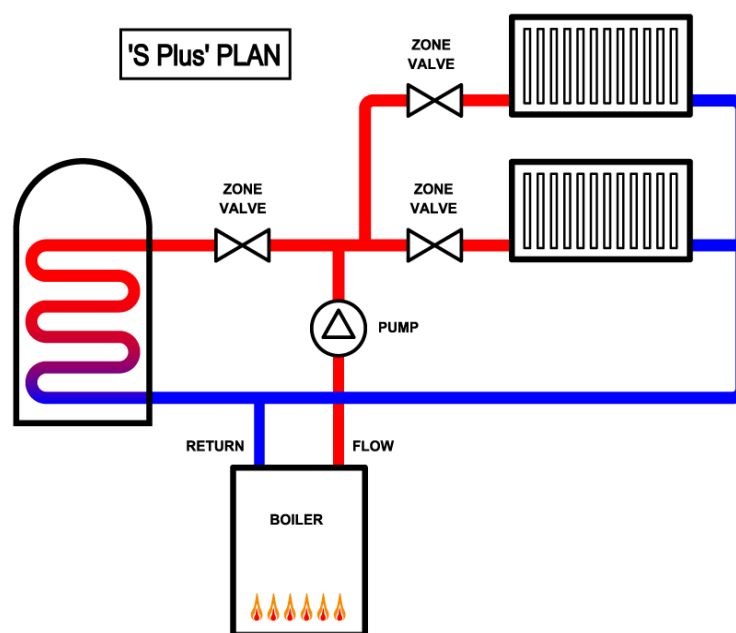

q) Expansion Vessel

**Location:** In the airing cupboard.

**Description:** There are two main types of Expansion Vessel dependent on what application you have.



Red Vessel (Heating) to be used on a Sealed System Heating application.

Blue Vessel or White Vessel (Potable Vessels) would be in a drinking water application such as an Unvented Water Heater or a Pumped System.



Potable Expansion Vessels are built from different materials than Heating Expansion Vessels to ensure that the water is contaminant free and safe for human consumption. With some systems the expansion is taken up within the cylinder (such as a Heatrae sadia Megaflor) instead of a potable expansion vessel.

Expansion Vessels operate on the basis that the internal chamber is separated by a rubber membrane, inside this membrane sits the water and surrounding this sits a pocket of air.

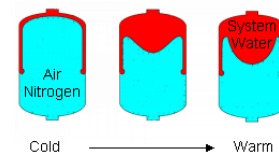

As the water inside the sealed system is heated the water pressure increases, as water is non compressible the air inside the air chamber of the Expansion Vessel will become compressed thus leaving the system safe from over pressurisation. As water can increase by 4.5% volume when heated from 0-100 °C. An Expansion Vessel is a vital part of any sealed heating system to accommodate the ever changing pressure and expansion in the system.

r) Tundish

**Location:** In the airing cupboard or boiler.

**Description:** It is installed on the discharge pipe to provide a visual window to the overflows and also provides an air gap to prevent an unsanitary cross connection between a discharge pipe and a sewer line or drain.



s) Pressure reducing/Balancing valve

**Location:** In the airing cupboard or in the kitchen sink unit.

**Valve type:** Pressure Reducing/ Balancing valve

**Description:** The incoming water pressure is reduced to 1.5 bar. The hot and cold supplies after this point are balanced pressure. The kitchen sink cold and outside tap are connected prior to this valve and therefore operate at the incoming main pressure. This device also contains a strainer that prevents debris and protects the system.



t) Accumulator / water Booster

**Location:** Roof space/Garage/Airing Cupboard

Water utility companies across the UK are struggling to cope with increased demand on the mains water infrastructure as more homes are built and household demand for water is increasing. The best way to describe an accumulator / water booster is like a battery storage system but for water. The booster system takes high pressurised water from the mains supply at times when no one is using it (at night) and stores it in an accumulator vessel under its own pressure.



The accumulator operates on the same principal as an expansion vessel with an internal rubber bladder that fills with water from the mains supply. As the water bladder fills it expands and squeezes the air space which retains the energy in the water pressure to be released like a balloon when you open a tap or need a shower.

Accumulators come in different sizes to suit the specific requirement of the property, storing from 6 litres to 10,000 litres so you can have as much or as little water stored and available as you want. The benefit of this is stable water pressure and flow to all taps/outlets with minimal drop off when more than one tap/outlet are opened simultaneously.

## 4. GAS

### a) Gas in your property

It is important for you to know where to isolate the gas supply.

The isolating valve (used to shut off the gas) is usually located in the gas meter box, as part of the gas meter.

If the meter box is located outside, then you would need a gas key to open the box, in which case ensure that the key is easily located.

If you live in a flat the gas valve will also be located in either a kitchen cupboard, wardrobe or a separate boxing marked and labelled emergency control valve.



### Emergency Control valve

**Location:** For flats the valve is located in the flat and indicated with a label containing the relevant details of your gas supplier in case of emergency.

**Valve type:** Lever valve

**Description:** Isolates all the gas in the flat after the valve.

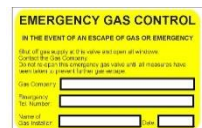

### Gas Cock

**Location:** Normally gas hob isolating valve in the kitchen unit next to sink.

**Valve type:** Brass gas valve

**Description:** Isolates the appliance for servicing.



### b) Gas Safe Register

**Gas Safe register is the only official list of gas engineers legally able to perform gas work on boilers, hobs, ovens, fires and all other gas appliances.**

Anyone carrying out gas work must have a Gas Safe Register ID card. If not, they are breaking the law and putting you and your family at risk.

Gas safety is one of the most important factors in having a safe home and work place. The dangers that surround unsafe gas appliances are deadly serious. Poorly maintained, faulty or badly installed gas work leads to carbon monoxide poisoning, the effects of which can be fatal.

It's not always easy to spot an illegal gas worker for a fully qualified Gas Safe registered engineer. Always ask to see your gas engineer's Gas Safe Register ID card to make sure they are safe and legal.

The Gas Safe register is there to make sure you don't fall into the trap of paying for illegal gas work with your health, and possibly your life.

### **GET you gas appliance safety checked every year**

Gas appliances that are left unchecked could be dangerous and leaking carbon monoxide. Your gas appliances, including your gas boiler, oven, hob and gas fires should be serviced according to the manufacturer's guidelines by a Gas Safe registered engineer.

If you do not have your gas appliances checked and serviced every year you could be putting you and your family in danger of carbon monoxide poisoning.

c) Flues & Chimneys

Flues, chimneys and air vents allow gas to escape from your home. You must keep flues, chimneys and air vents clear so that fumes can escape easily.

**Never** block these airways to prevent a draft. Blocking ventilation is dangerous and could result in carbon monoxide building up in your home.

Any gas safety record given to you after 1 April 2009 will only be valid if the engineer is registered with Gas Safe Register.

d) Gas Safety Certificates

Any time your gas appliances or pipework is worked upon or serviced, your Gas Safe registered engineer will give you a gas safety certificate. This certificate tells you that the gas appliance and pipework is safe and the work meets the right standards and regulations. It will also tell you when you next need to service the appliance (if a service).

e) Gas Certificates

Your Gas Safe registered engineer may give you gas safety information to show your gas appliances are working safely.

After a Gas Safe registered engineer has fitted or serviced your gas appliance, they will often leave you with a report which explains what checks they did. This report may be issued as a gas safety certificate, sometimes referred to as a gas safety record depending on the work undertaken.

It isn't a legal requirement for your engineer to give you this type of information, but many Gas Safe registered engineers will provide it or similar as a matter of course.

The gas safety information tells you that the gas appliance or gas fitting has been checked to see if it is working safely and meets the correct safety standards. This information may also tell you when you next need to service the appliance.

It's important to get your appliances regularly serviced to make sure they are working efficiently and safely. You should also have a gas safety check done on all gas fittings and appliances every year.

f) Do you live in a rented property?

If you rent a property, ask your landlord for a copy of the current Gas Safety certificate. This certificate shows that gas appliances have had an annual gas safety check by a Gas Safe registered engineer. Landlords must also maintain gas appliances, so check the date when yours were last serviced as well.

g) Are you a landlord?

Landlords must be able to provide their tenants with an up-to-date Gas Safety certificate.

By law, landlords must have all gas appliances serviced regularly, normally once a year by a



Gas Safe registered engineer. The Gas Safe registered engineer will provide a Gas Safety certificate upon completion of the check.

h) What information does the Landlords Gas Safety certificate contain?

As a minimum, the certificate of a gas safety check must contain:

- Description and location of each appliance and/or flue checked
- Name, registration number and signature of the engineer who carried out the check
- Date on which the appliance and/or flue was checked
- The address of the property at which the appliance and/or flue is installed
- The name and address of the landlord (and the letting agent if applicable)
- Any defect identified and any action required or taken to fix it
- Confirmation of the results of operational safety checks carried out on the appliances

i) Are a gas safety check and a service the same thing?

Not quite. A service includes a thorough clean of the appliance as well as the gas safety checks.

For a gas safety check or a service, essential safety checks are done to make sure gas fittings and appliances are safe to use. These checks include;

- Checking the flue or chimney to make sure the products of combustion (fumes) are being safely removed to outside.
- Checking there is an adequate supply of fresh air so the gas burns properly.
- Checking the appliance is burning the gas properly.
- Checking all safety devices are working properly and shutting the appliance off if a fault occurs

j) Are you a homeowner?

Building regulation certificates Since April 2005, there has been a requirement under the Building Regulations (England & Wales) to notify building works (including the installation/commission of some gas appliances homes).

Gas Safe registered businesses are able to carry out this notification for you through a self-certification process available through Gas Safe Register.

If gas appliances are notified through this system, as the homeowner you will receive either a Declaration of Safety certificate or a Building Regulation Compliance certificate, to make sure that you are receiving the correct certificate you can view examples of both the Declaration of Safety certificate and the Building Regulation Compliance certificate online.

## 5. DRAINAGE

Although a relatively simple aspect of your home, it is no less important than the heating system and plays a vital part in your day to day comfort of your home.

All soil and waste pipes are installed to a fall towards the drains to aid the removal of waste, without leaving any debris in the system, which if left could cause build up and eventually blockage.

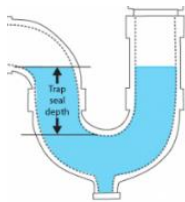

Water traps are installed to all appliances to prevent smells rising up from the drain. If not used regularly these can dry out and smells can rise up. If this is the case run your water into the trap for a short period to refill the trap and seal the pipe from smells.

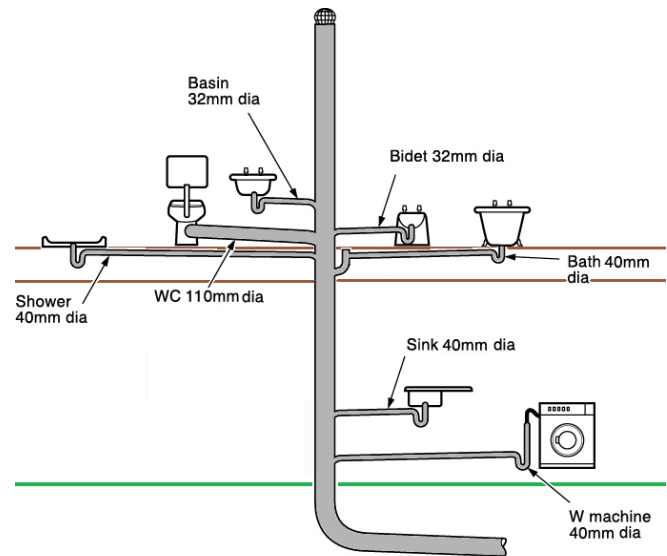

Occasionally your waste and drains can block up, a simple and effective way to clear the waste is with a plunger.

- Block any overflow hole with a damp cloth
- Place the plunger over the waste hole and fill the appliance so the plunger is immersed in water
- Push the plunger down in a sharp quick movement. You are trying to free the blockage and push further down the pipe into the main drain. If this doesn't cure the issue seek advice.

One of the commonest call-backs we get is because water continues to flow into the pan after flushing. A bit of background on your WC cistern, is since 2001 building regulations have dictated that the WC cistern is limited to a maximum 6 litres in water and the lower volume is a maximum of two thirds - i.e. 4 litres if the greater volume is 6 litres.

Manufacturers have had to change the design to gain a full flow flush in the 6 litre permitted. So they now all use the internal valve known as a "Drop" or "Flap" valve mechanism where the valve is open for the whole duration of the flush.

There are lots of reasons for these valves to let by but the main reasons are as below:

1. The float height on the inlet valve could be set too high allowing the water to flow into the internal overflow. This fault tends to be dealt with prior to occupation and

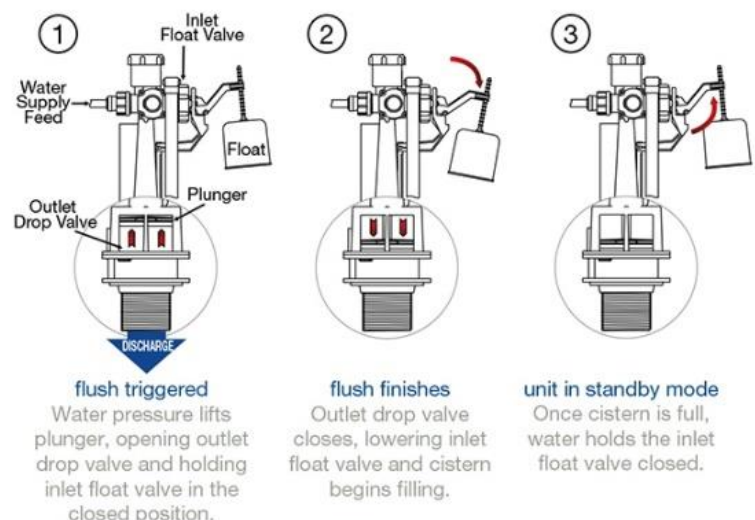

highlights itself during testing stage.

2. The inlet valve could have developed a fault and not closing off properly causing the water level to spill into the internal overflow. Although there are filters on your system occasionally we find grit bypasses these and finds its way into the float valve and holds it open.
3. The flush buttons could be sticking forcing the valve open. This can be cured by loosening off the clamp that holds the buttons, or easing the cistern off the wall slightly.
4. The Drop valve could be faulty.
5. The Diaphragm washer / seating could be incorrect. This is the most common error.

The rubber washer normally has warped or a bit of grit or scale build up and doesn't sit properly in the closed position. The water filling the cistern cannot fill quick enough to apply the downward force to close the seal, so it continually lets by.

The washer can be wiped clean and a bit of silicon lubricant applied to aid the seal.

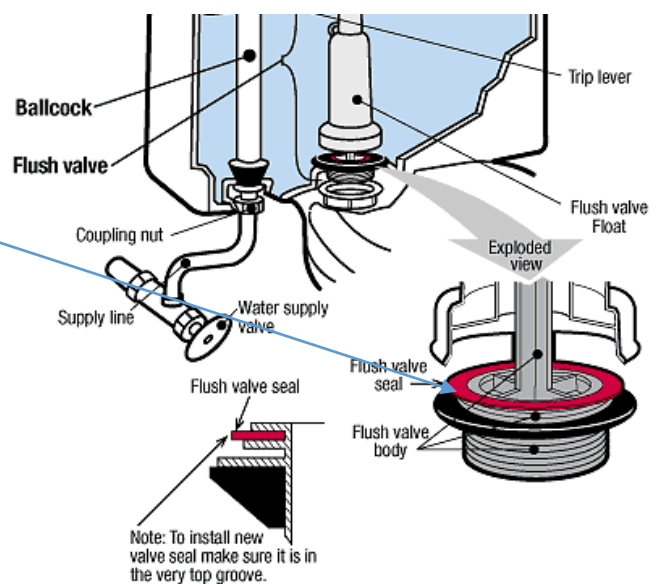

## 6. GETTING THE BEST FROM YOUR SYSTEM

### a) Types of heating system

All central heating systems have three components: a heat (or energy) source (e.g. mains gas), a distribution medium (e.g. water that flows through the system), and a heat emitter (e.g. radiators or underfloor).

The most common distribution medium for heating in the UK is water (called a 'wet' system), which can be high or low temperature. These systems transfer heat via an emitter being either a radiator or underfloor or both.

Central heating, fuelled by mains gas is still the most common type of heating in the UK. A boiler heats water, which is piped round the building to heat radiators. It also heats water for washing and bathing.

An efficient heating system is one that uses the least amount of energy to achieve the desired level of warmth. Making your heating system as energy efficient as possible is likely to be a combination of changing the way you do things, and adapting or changing the controls, or the whole system.

### b) Low or high temperature central heating?

Traditionally, radiators fed by central heating systems operate at higher temperatures (from 60 to 80 °C). A lower temperature flow (as low as 35 °C) is becoming more common, and is desirable because it is more efficient.

Low temperature heating is common in underfloor heating, which can operate at around 35 °C, but is also possible and increasingly common with a radiator system, used in conjunction with an air source heat pump, the radiators are increased in size to accommodate the lower temperature flowing through to achieve the heat output required for the room.

The general view is: -

- Lower temperature heating system, it is more efficient to leave the heating on continuously.
- Higher temperature system it is more efficient to turn it on around key demand periods.

However with modern new build houses this is not necessarily the case as heat loss from a building is proportional to the inside/outside temperature difference, but the more airtight and well-insulated your building is, the less this becomes important, and it becomes more a lifestyle choice.

### c) Controls

The controls are your tools for making your central heating system run as efficiently as possible. The more actively you manage them, the more efficient it will be. If you just programme in some times and leave them until it's warm enough to turn the heating off in spring, you will use more fuel, and have higher bills, than if you fine tune according to the time of year, and how you use your property.

- **Zone valves:**

Modern properties have zoned heating systems. They provide separate heating zones (normally bedrooms and living rooms) to control at differing temperatures.



- **Programmer:**

This is where you can set the on/off times for your heating and hot water. It's worth making sure that you can control the heating and hot water separately if you have solar water heating.



- **Room thermostat:**

Your room thermostat controls your home's temperature, so once it hits the temperature you set on the thermostat, the boiler will go off. When the temperature goes below the setting on the stat, it then turns the boiler (and thus the heating) on.



Conventional thermostats dial control are accurate to +/- 5 °C. Digital thermostats are much more accurate, and some programmable digital stats have set back times, this is where they will reduce the heat during the night to 16–17°C at night.

Turning a programmable room thermostat to a higher setting will not make the room heat up any faster. How quickly the room heats up depends on the design of the heating system, for example, the size of boiler and radiators.

Our view is that you should work on comfort levels rather than temperature. Thermostats should be set to the lowest comfortable temperature (typical levels are between 18 and 21 °C, however this can alter due to personal preference in comfort levels).

- **Thermostatic radiator valves (TRV):**

Thermostatic Radiator valves (TRV) are an extra control which you can use to set the temperature of each individual room. These are the most basic form of zone control. Fitted to individual radiators, they allow you to control the heat in each room.



To be effective they need a free flow of air to sense the temperature in the room, so shouldn't be obstructed by furniture or curtains, and should not have a radiator cover.

The use of TRV's prevents individual rooms being 'overheated'. Without TRV's the only temperature monitoring and control is done by a room thermostat; this covers the whole house rather than an individual room. Some rooms will warm up quicker than others, so a major benefit of a TRV's is it will maintain comfort.

The radiator in the room with the room thermostat will not have a TRV on the radiator as well, as this could close the heat to the radiator and then the room thermostat will be getting a false reading of the temperature.

- **Cylinder thermostat:**

Thermostat on the cylinder to switch off the boiler once the water reaches the required temperature. To maximise efficiency it is recommended that this is set at 60 °C. It should not be lower than this to prevent the risk of legionnaire's disease.

- **Boiler thermostat:**

This should be set at 65 °C, to enable it to deliver water of 60 °C (see above). While radiators will get hot quicker if the boiler thermostat is set at a higher temperature, the boiler may not condense, which will reduce its efficiency by 10-20%.

- **Weather compensators:**

These are installed on a north facing wall and register the outside temperature and can adjust the boiler heat setting to operate in its most efficient temperature. They can make your heating system more accurate than using thermostats.



d) Operating your heating

The objective is to obtaining the right level of warmth for the minimum use of fuel. What's the right level will depend on your lifestyle and your family. It will be different for a single person who spends most winter evenings in one room and a family with children who may need the heat in more rooms.

Your property has been designed on a room by room basis, with hallways and bedrooms having lower temperatures than kitchens and living rooms.

- With TRV's on your radiator try turning it down a little at a time until you find the room temperature you want.
- In cold snaps it's tempting to turn the thermostat up. However, it's not the overall temperature of the system that's the problem. It's that it takes longer for the house to warm up because it's starting at a lower temperature and the fabric of the building takes longer to heat. Therefore you may need to account for this and program the heating to come on a bit earlier.
- It's better to keep doors closed for the area you want heated. Radiators and underfloor all work by creating a convection current in a room. As hot air rises, it circles around to the other side of the room, cools and sinks and travels back along the floor to the heater to be reheated again.
- Closing doors makes sure this current remains within the designated space, and therefore reach its design temperature in the optimum time, and you are not wasting heat heating empty rooms such as bedrooms during the day.

When it comes to operating your system there are two schools of thought on how you should operate your heating system.

- According to the Energy Saving Trust. They're clear that you'll save energy, by only having the heating on when it's required.

The basis for this is that it's a given that a certain amount of energy is constantly leaking out of your home (With modern homes there has been great emphasis on insulating your home to high levels to prevent heat loss). Their basis being, if you're keeping the heating on all day you're losing energy all day. Therefore their view is it's better to heat your home only when you need it.

- Others advocate keeping the heating on low all day, with the room thermostat turned to say 10 °C when you are out. The view being that the problem with turning the heating on

and off is that every time it's turned off, condensation collects within the cavity walls which you then have to reheat. The analogy commonly used is the principal being if you are wearing wet jumper it takes longer to get warm than a dry one being worn. Therefore the condensation can help conduct heat outside the home, meaning you leak heat more quickly and so will use more energy reheating as a result. By running your heating constantly (although the boiler only comes on when required) the fabric of the home is kept at a constant temperature. Also your reheat time is quicker so you don't feel cold waiting for the house to warm up.

Our advice is to try both and see which is suited more to you and your family's lifestyle best.

### e) Operating your hot water

With your hot water you can apply the same principals as the above to the heating to keeping on constant or timed off as needed?

The hot water cylinder contains high levels of insulation, with heat losses in the cylinder ranging from 0.89 to 2Kwh/24hr period depending on the size with reheat times after drawing off 70% Range from

- Gas boiler 14 minutes for 120 Litre to 26 minutes for 250 litre.
- Immersion heater (based on 1no. 3KW immersion), 130 min for a 120 litre to 224 minutes for 250 litre cylinder.

Therefore if you had a 250 litre cylinder and no hot water was used over a 24 hour period, your gas boiler would have to turn on and heat the hot water in the region of 60 minutes to reheat (this would be over several periods of the day when the water drops below required temperature). Based on this it is recommended to operate the hot water off of a timed basis.

Hot water cylinders have one or two immersion heaters (3kw) depending on size. These operate as a backup should your boiler fail. To operate turn on (normally a switch on the wall in the airing cupboard) and leave on at the switch it will heat the hot water and once up to temperature it will close off until required again.



### f) Operating underfloor heating.

Underfloor heating works like having a big radiator under the floor: hot water is passed through coils under the floor, which rises up to heat the room.



Underfloor heating usually operates between 35-45 °C, and are ideal for condensing boilers which require a lower return water temperature to condense. This system also is suitable for air source heat pumps, again due to the lower temperature water the system provides.

Because underfloor heating is a form of low-temperature heating, it is most suitable to spaces that are well insulated and with less air exchange. It is most effective left on for extended periods rather than heating at key times.

Imagine that your underfloor system is just like a very large radiator. The larger the radiator, the lower the temperature of the water within it needs to be in order to keep a room warm. Now imagine that that radiator is set in concrete screed within the floor. In order for the heat to penetrate into the room, not only does the water need to warm the pipes it runs through, as with a regular radiator, it now also needs to warm that screed.

To get the pipes and the screed up to temperature takes a lot of energy. Repeatedly turning the system on and off, as you would with regular radiators, will waste energy heating the screed. However, once both pipes and screed are warm, they will hold the heat efficiently.

Keeping your heating on constantly and your thermostat set low, means your room will stay consistently warm without having those very energy intensive peaks and troughs in temperature or long periods of cold while you wait for the system to heat up.

#### How to optimise running you underfloor

It is best to run the underfloor heating 24/7 during winter. With zone valves the underfloor heating system can work completely independently from radiators.

In the summer you can refrain from running or run at a nominal temperature, autumn and spring we would recommend that you run as standard and adjust the room temperatures to suit comfort levels. You need to take into account if you do not run and we have a cold spell the system could take 24 hours to reach the desired temperatures as the screed is being heated.

#### g) Operating solar hot water.

While the control systems for the solar system are very sophisticated, they primarily rely on sensing temperatures in the hot water cylinder and comparing to the temperatures within the solar array on the roof. Once the control system sees a solar array temperature 8°C greater than the temperature within the lower part of the hot water cylinder, then the system pump will begin to operate at an optimal speed to gather the maximum possible solar energy.

When the two temperatures come within 4°C of each other the pump will cease to operate.

- The solar pump station should not be touched, it is pre-set for your type of system at commissioning stage. The buttons on the controller are for information only. They are there to indicate the temperature of the water in the cylinder, the temperature of the fluid in the solar panels and to indicate the pump running and speed.
- The power to the solar system should always be left on.
- Use your main central heating programmer to ensure that water is only heated by the back-up heating source (i.e. the boiler or immersion) after the water has been heated to the maximum extent possible by the sun.
- Ideally you should be aiming to set the hot water heating programmer to time the hot water not reheat hot water during the day when there is no hot water demand and use the opportunity to gather solar energy from the sun.

When you use hot water during the evening and early morning hot water, you will ensure that there is plenty of cold water in the cylinder for the sun to heat the next day.

- Using the boiler to heat your hot water in the morning will make the solar ineffective, as you will have heated the water before your solar has had chance to heat the water and as the water will be up to temperature the solar won't come on.

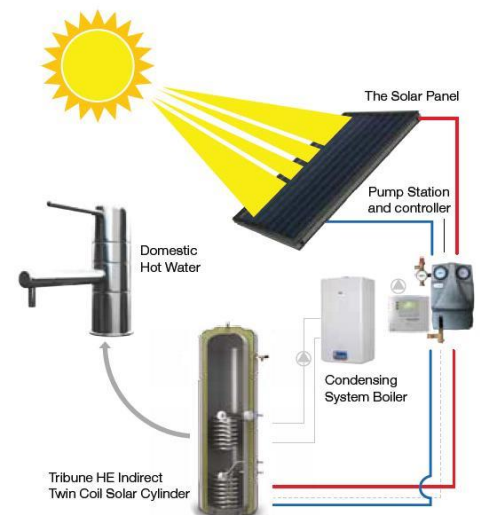



It will be best to experiment and have your hot water off on the boiler in throughout the daylight and see if this can meet your life style with your water usage. Take into account your cylinder reheat via the boost on the programmer to bring your boiler on will provide you with hot water in a relative short period of time.

The solar panels will also collect heat when the sun is not out and even in winter depending on sun radiation over half the hot water requirements throughout the year can be attained from your solar panels if you operate correctly, according to government statistics, 80-90% in the summer, 40-50% in spring and autumn and 20-30% in the winter

It's always important to look at the relevant part in your solar thermal user manual, but the most important advice is to leave your system turned on. It has been designed to endure long periods of low to zero hot water 'draw off'.

Ideally you don't want the collector temperature to go above 120-140 °C as the fluid within will vaporise and 'stagnate', which puts the system under additional stresses and strains and reduces the effective life of the solar fluid.

When your system was designed it was factored to keep 'stagnation' to an absolute minimum. Stagnation occurs when excessive temperature in the collector causes the fluid to evaporate, as the system is under pressure (this usually takes place at 120 °C). We know that this is going to occur occasionally during the summer months and holiday periods. Each time stagnation occurs it reduces the effective lifespan of the solar fluid and causes additional stresses and strains on the system components.

Some solar programmers have a holiday mode setting to avoid the fluid stagnating, please refer to the user guide for directions on how to set.

Please note that if you have a power cut you may have to reset the times in your solar controller.

## **7. SERVICING AND MAINTENANCE.**

### a) Boiler service

Boilers have an effective lifespan of 10 years, to keep them running they should be checked annually to ensure they are working efficiently and safely, only a Gas Safe registered engineer can conduct this work. Neglecting to service your boiler on a regular basis can result in it running inefficiently, which will increase your utility bills and shorten the life of the boiler. Un-maintained boilers can release carbon monoxide, an odourless gas that kills a significant number of people each year, but most commonly they simply stop working. If you don't service your boiler you risk it breaking down when you need it most.

Over time the water in your heating system will potentially start to corrode, causing a black sludge deposit, which is a result of the reaction with the water and steel in the radiators. This can cause damage to boilers, pumps, pinholes in radiators and block or restricted flow through the system.

All our systems are treated with Fernox inhibitor which slows the process down. Overtime the chemical breaks down and becomes less effective, so it should be checked and re-dosed as part of your regular service.



A routine service is generally a lot cheaper than an emergency call out.

A boiler service should include

- 1) A visual check to ensure your boiler still meets current standards
- 2) Boiler fired to identify any working faults, just because it looks ok the boiler could be burning inefficiently
- 3) Boiler casing removed to check all main boiler components (burner, heat exchanger, main injector, spark/sensor probe).
- 4) Checks to ensure flue terminals are unobstructed and internal flue components are sealed properly
- 5) Gas valve adjusted to check that burner is combusting efficiently and properly (normally using a flue gas analyser).
- 6) Inside casing surfaces cleaned
- 7) Boiler parts cleaned if necessary
- 8) Gas tightness test conducted to ensure no leaks
- 9) Boiler casing put back on - check that properly sealed
- 10) Check bypass valve working correct
- 11) You should receive a service report that shows everything the engineer has done to maintain your boiler.

The Procedure should consist of

- 1) Remove main burners, clean and inspect for damage.
- 2) Clean and inspect gas injector(s).
- 3) Dismantle and clean pilot assembly and gas injector.
- 4) Reassemble burners and pilot assembly.
- 5) Check condition of ignition leads and electrode.
- 6) Clean the heat exchanger.
- 7) Refit burner assemblies and check seals.
- 8) Test disturbed gas joints for leaks.

- 9) Check appliance case and seals (where appliance is room-sealed) for damage and correct assembly.
- 10) Measure gas pressure and flow rate, and adjust if necessary.
- 11) Inspect/test flue for faults/correct operation.
- 12) Inspect flue terminal for correct location and protection.
- 13) Check system bypass valve is correctly adjusted.
- 14) Check sealed system is at correct pressure.
- 15) Check corrosion inhibitor levels in system and re-dose if necessarily
- 16) Advise user of any defects found in writing.
- 17) Apply the Industry Unsafe Situations Procedure if necessary.

b) Unvented hot water system

Regulations governing the installation of hot water systems place the responsibility for the safe installation of the system on the installer. Customers must be made aware that periodic checks of the equipment are essential for continued safe and efficient operation.

Maintenance and inspection periods will vary for many reasons; some manufacturers recommend a maximum of 12 months between inspections to coincide with boiler maintenance. Experience of local water conditions may indicate that more frequent inspection is desirable, e.g. when water is particularly hard or scale forming or where supply contains a high proportion of solids such as sand or sediment.

Servicing Procedure

- 1) Remove and thoroughly clean any filter/strainer.
- 2) Check integrity of cylinder for leaks or damage etc.
- 3) Check air charge pressure in expansion vessel
- 4) If the system has internal type expansion facility, re-set expansion gap whilst testing of the temperature/pressure relief valves.
- 5) Manually rotate the cap to operate the expansion relief valve. Check that opens, closes and reseals correctly. If there is any doubt replace the valve.

*Often these valves drip or let by overtime as they seal against the temperature and pressure variations of your cylinder heating and cooling. NOTE, pressure and temperature relief valves are not covered under warranty, and replacement of these valves are part of your service procedure.*

- 6) Manually rotate the cap to operate the temperature and pressure relief valve. Check that it opens, closes and reseals correctly. If there are any doubts replace the valve, ensure the connection is not scaled.
- 7) Check discharge pipes D1 and D2 for blockages or obstructions. Check termination position.
- 8) Check storage and delivery temperature settings and the operation of controls or motorised valves.
- 9) Check sacrificial anode (if fitted) and renew if necessary.
- 10) Check heat exchangers (coils) in hard water areas and de-scale as required.
- 11) Check the water pressure downstream of pressure reducing/limiting valve.
- 12) Check water pressure and flow rates at terminal fittings.
- 13) Check and clean flow diffusers on taps (if fitted).
- 14) Explain works carried out and hand over to customer.

Note, when inspecting combination valve it is worth changing the "O" ring seal as a matter of importance as they may become damaged during maintenance.

c) Solar

Solar thermal heating systems are generally low maintenance which require little regular planned servicing (we recommend every year with your boiler and cylinder). The only moving part is the pump which is a relatively low cost item and reasonably easy to change. The electronic controllers sometimes fail, albeit rarely.

The main thing to watch out for is fluid leaks – especially the glycol (antifreeze) which runs through you're panels and into the cylinder smells rather strong. If there is a leak contact your installer.

Make sure your solar system is doing what you expect. If the weather is sunny and your hot water cylinder is cold you may wish to investigate further.

Similarly if the pump is running but the solar pipework is cold you may have an airlock which we can sort out for you.

Check the pressure of the solar system which should be between 1 and 2 bar – although it can drop as low as 0.5 bar in cold weather as the fluid contracts and as high as 3 or 4 bar if the system gets very hot. This is nothing to worry about but if the system falls below 0.5 bar and stays there, please contact us and we can re-pressurize, any glycol that leaves the system is collected in a container in your airing cupboard.

As part of the service the solar pressure vessel pressure setting needs checking.

The antifreeze in your system will need the acidity (to be checked with a refractometer) as it will degrade over time and need replacing eventually.

Antifreeze is designed to cope with temperatures as low as -28C; the coldest temperature ever recorded in the UK is -27C. Therefore the system should be fine for 10 years or more. Manufacturers tend to recommend changing every 5 years.

## 8. COMMON CENTRAL HEATING AND HOT WATER ISSUES

### a) How to tell what the current pressure of the system is?

Every pressurised system, regardless of the type of boiler (combination boiler or standard or system boiler), will incorporate a pressure gauge or an electronic gauge on your boiler (please refer to your boiler instructions will indicate where the gauge is if integral). This pressure gauge is the device with which the system water pressure in your heating system is monitored.



To maintain the system in a healthy condition the pressure gauge should be checked monthly. If when you check it, you find that the system pressure has fallen below 1 bar, please follow the steps below to re-pressurise your system.

Your boiler instructions will advise of the pressure that your system operates at. Most systems should be pressurised to between 1 and 1.5 bar. Manufacturers normally state 1 bar, however most systems you will find are pressurized to 1.5 bar, to allow a moderate venting of radiators without effecting the boiler operation.

### b) Why is Discharge overflow is leaking outside and dripping water in airing cupboard

The can happen for several reasons.



- A failed or de-pressurised expansion vessel (or cylinder air gap if a Megaflo) is a common cause when water passes out through the safety pipe, to stop the pipework bursting if the expansion vessel fails, the system is fitted with pressure relief safety valve, which will let by if pressure rises.
- Also it is not uncommon for the pressure relief valves to fail, as they are constantly working and moving against the ever changing pressure of your hot water cylinder as the water heats and cools.
- If the pump fails or sticks the pressure can spike above 3 bar forcing the pressure relief valve open and water passes out of the system along a safety pipe and is dumped or slowly dripped to outside the building.
- If the secondary plate heat exchanger on a combination boiler is leaking internally, water will probably be forced out through the safety valve and the pressure gauge will read consistently around 3 bar.

### c) Why is the expansion vessel failing

There are 3 ways the air pocket from an expansion vessel can be lost:

- The Schrader valve (car tyre type valve) can be leaking. 
- The rubber diaphragm in the expansion vessel is semi-permeable to air and over time air can pass across it, dissolving in the system water.
- The expansion vessel diaphragm slowly perishes and ruptures, losing the air into the radiator system where it may be bled out of a radiator.

### d) Why is my system pressure low?

Most of the issue you will find with boiler, hot water and central heating issues are because the pressure has dropped, and can be resolved by re-pressurizing the system.

To top up your system and increase the pressure, you will need to locate your filling loop. It most usually resembles a stop tap and is connected to the central heating system by a metal hose.

Occasionally you may find that one end of the metal hose is not connected to the pipe work on your system. There may be a cap on the end of the pipe and it will need to be connected to the system to allow the water to be injected.

The filling loop in most properties is installed in the airing cupboard with the cylinder, in some instances it is the filling device may be hidden, behind a baffle near or below the boiler or perhaps inside a kitchen cupboard below the boiler.

Another issue in finding the filling loop may be that some filling devices are an integral part of the boiler, you should have been advised of this by your builder at handover stage. You will need to refer to your boiler manual for the exact manner in which this system is re-pressurised, however across the board the general principal is the same.

Below is examples of alternative filling devices 1 to 3 are devices located on your boiler and device 4 is the standard arrangement in your airing cupboard.

1, Flexible filling loop,



2, Rigid filling loop



3, A filling Keys



4, Standard filling loop



If the system is free from leaks the water pressure should remain constant within the system in future months. If you notice that the pressure regularly falls you may have a pressure leak. Please note the pressure will go up and down with the heating system being on and off.

Bleeding radiators involving perhaps a small amount of air escaping from a system at the radiator bleed point can reduce the overall system pressure. As a result after bleeding your radiators you should remember to check your pressure gauge and fill the system as required. Water leaks will cause pressure loss within a pressurised central heating system and the severity of water leaks can vary. Very small leaks will cause pressure drops over a long time, possibly several months or even a year. Leaks of this magnitude may not be detectable as the water evaporates quite quickly although you may spot some residue following evaporation of the water.

Larger leaks may be more visible and will mean your system will require filling as frequently as once or twice a week. If this is the case you should check your system for leaks when it is cold paying particular attention to the areas around radiator and boiler valves. It is recommended that you check for leaks when the system is cold as heat causes expansion and can seal small leaks temporarily. Sometimes these need to be monitored over a period of time to establish the source.

e) How do I increase system pressure?

The pressure is on zero or below one, and the boiler will not fire, or only some of my radiators are not getting warm.



1. Locate the filling loop, or filling tap assembly. It will hopefully be assembled such as the one on the right. If not, you will need to hand tighten the flexible hose onto the taps (there may be caps we need to remove from the taps first, make sure the valves are off), screw filling loop on and once hand tight use a pair of grips to give a final tighten  $\frac{1}{4}$  to  $\frac{1}{2}$  turn.
2. If you have a system or combination boiler the filling loop maybe located under the boiler or in a cupboard nearby.
3. You are aiming to add around 1 to 1.5 bar of pressure in the system. If you cannot see your pressure gauge while filling the system it is a recommended to have a friend look at it for you while you are turning the tap.
4. When you look at the filling loop the valves are closed when they are at a right angle to the pipe.
5. You may only have one black tap to turn, you may have two, or you may even have a screwdriver slot at both or one end. However the on and off position are the same in both instances.

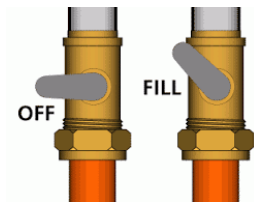

The taps will only turn one way. If a screw driver type valve these will turn 360 degrees but off and on position are the same as the tap positions.

6. Open one tap fully, then followed by the other valve, when you do this you will hear water entering the system.
7. At this point, the needle, or display on the gauge will start to rise, sometimes there is a delay while pressure builds. The red dial will not move this is just a manual indicator. Remember you are aiming for 1.5 bar
8. Don't worry if you put too much in the system (2 bar and above), as the pressure relief valve will discharge the excess water in the event of too higher pressure.



However, it is best to get it right first time, as the safety mechanism can keep on dripping once it's started, and then you'll keep having to top up the pressure!

9. If you find your system has discharged the excess pressure, then just repeat the process until pressure at 1.5 bar.

f) **My boiler is not working?**

If your boiler is not working there are simple tasks you can do to get it working again.

1. Check Power supply

- i. Check the main circuit board hasn't tripped?
- ii. Check the fused spur hasn't been turned off, normally located underneath the boiler (maybe a toaster has been pushed back against it?).
- iii. Check the fused spur hasn't blown. This has a 3 amp fuse installed to protect the programmer and the boiler from blowing, if you find a 13 amp installed, change for a 3 amp, or request the electricians attend.
- iv. Check the programmer on, lights on?
- v. Check the lights on in the boiler.
- vi. Has there been a power cut, has the main board tripped and need resetting?
- vii. Your programmer may have reverted back to its factory settings?
- viii. Do the batteries need changing, some programmers and room stats are battery operated.



2. Check the Gas supply,

- i. With modern gas meters it is not uncommon for them to lock out and cut the gas supply to the property, if you have not got a gas hob or fire to check supply. Open your meter box the screen should say if locked out and tell you how to reset. Normally just pushing button B then A.



3. System pressure, is it below 1 bar? This is the most common cause for boiler failure.

- i. Check you pressure and if need be recharge system if required, as explained previously.



4. If the temperature is below freezing outside, your condense pipe on the boiler may have frozen.

- i. Warm some water and gently pour over the frozen pipe until thawed.

5. Check your heating controls,

- i. The programmer may have blown, (is it loose on the wall, poor electrical connection).
- ii. The programmer may not be asking for heat, turn onto constant
- iii. Room stats could be turned down.

6. Reset your boiler

- i. Try resetting your boiler by pressing the reset switch on your boiler, turning your boiler on and off on its controls.
- ii. Turn on and off the fused spur.

If you have gone through all of the above and it still does not work, please call us for advice.



**g) There is only hot water or heating not both?**

- i. Your hot water thermal cut out stat may have tripped and require resetting (referrer to cylinder instructions), this is normally just a case of resetting the button.
- ii. Your zone valve maybe sticking manually move the auxiliary switch to see if you release and solve.
- iii. Your zone valve may have failed, see if the auxiliary switches move or become loose when on.

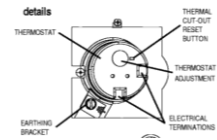

Set the programmer calling for hot water only to on, and see if this valve moves and repeat for each valve / heating zone. If you find one doesn't move it may indicate the valve or room stat is faulty

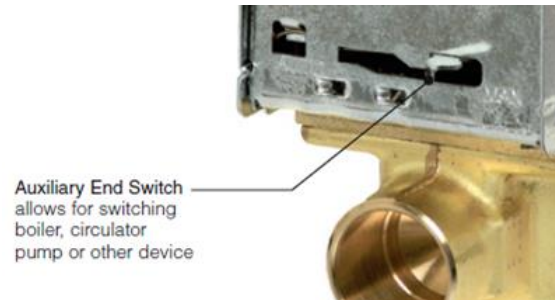

## 9. WARRANTY

Your home is covered by a two year NHBC warranty, on defects and products.

However the warranty does not cover the following.

- It is the homeowner's responsibility to provide access for us to attend to the issues raised, during working hours from 9.00 – 16.00 Monday to Friday.
- It is the homeowners responsibility to maintain and service the property in accordance with manufacturer's instructions i.e. boiler, cylinder and system every 12 months. Failure to produce a current service record will nullify your warranty, **NOTE** manufactures will refuse attendance without being sent proof of service prior to attending.
- Any issues with blockages to the sewer of waste system due to inappropriate products being introduced by the occupier (i.e. baby wipes)
- Any damage caused by severe weather.
- Certain components within the property only carry a 12 month warranty from the manufacturer's i.e. expansion vessels, temperature and pressure relief valves etc. If past the manufacturer's warranty period any remedial works are at our discretion and costs may be passed on.
- Normal wear and tear, deterioration or damage caused by neglect, damage from accidents or misuse
- Any costs/expenses, professional fees incurred by the homeowner to fix a defect which has not been formally reported and approved in writing and costs agreed prior to works being undertaken.
- Loss of enjoyment, inconvenience, distress or any other consequential loss suffered as a result of remedial works being undertaken.
- Damage of items due to issues not reported in a reasonable timescale.
- Damage of items where the homeowner has not mitigated their loss.

If we are requested to resolve any issues not covered under the warranty we reserve the right to pass any costs on at our discretion.

## 10. WARRANTY EMERGENCY CALLOUT (2 YEAR NHBC COVER)

We operate an out of hour call out service for our clients, where we will try to attend as soon as possible.

Please contact your emergency callout number as first port of call. You can try the office number 01865891955 or alternatively email [mail@renelec-chalgrove.co.uk](mailto:mail@renelec-chalgrove.co.uk), make sure the email contains all contact details including address, email addresses, contact numbers, details of the issue and if possible photos to aid diagnosis.

Other than general items, we also exclude as an emergency and attend in normal working hours

- Noisy systems
- No heating (May to September).
- No hot water (if a backup is present i.e. immersion heater).
- No pressure in heating system (deemed to be under occupiers duty of care)
- W.C. out of use (if other toilets in the property, and possible to temporary flush with a bucket/bowl of water)
- Shower and or bath out of use.
- NO water to the property if occurrence is also to properties in the area, as deemed to fall under your water supplier.
- No gas to the property (falls under the remit of gas supplier) (if an electric gas meter check to see if has tripped, see previous page item 2)

Mastic, it is not uncommon for failed mastic being cause for leaks from showers and or baths. Where water leaks through to the ceiling below. We do not carry out any mastic works and these works fall within other trades warranty cover. If you do have a leak from the bathroom or shower it is worth inspecting the mastic around the bath or shower tray as these are the most common causes.

Manufactured product and component failures, fall under the manufactures warranty procedures. We will pass on the details during the out of hour's period, and apply pressure on your behalf. However once we pass the job forward. The manufacturer contacts and arranges all access direct with homeowner, to carry out the works in the timeframe they operate in.

## 11. Frequently asked questions

- 1) I am going on holiday should I do anything?
- 2) How do I prepare for an emergency?
- 3) What do I do if my pipes burst?
- 4) How do I bleed radiators?
- 5) What do I do if I smell gas?
- 6) Should central heating be used in the summer?
- 7) My boiler is not working do I have back up for hot water?
- 8) What is an immersion heater?
- 9) What is Central Heating?
- 10) What is a condensing boiler?
- 11) What is a condense pipe?
- 12) My water is chalky?
- 13) My water from the tap is cloudy?
- 14) Why Do I Have Blue/Green Staining Of My Bathroom Fixtures?
- 15) What is the best way to clean my bathroom suite?
- 16) My wc seat hinges are rusty, how do I clean?
- 17) My shower drips and sometimes dumps the water?
- 18) Why is my bath hot colder than the rest of my house?
- 19) My shower is slow to drain?

### 1) **I am going on holiday should I do anything?**

If your home is going to be left unoccupied for long periods of time it is advisable to

- Shut the main stopcock off (normally located under the sink)
- Leave the central heating on a timer for short periods to prolong the life of certain components. The room thermostat should be turned to its lowest setting to limit waste
- In the winter months it is advisable that a neighbour makes regularly checks on your home.
- Check your solar if a holiday setting on programmer

### 2) **How do I prepare for an emergency?**

We realise this sounds simple but, Read this document and familiarise yourself with your system. Know what the components are and what they do. Find where you can

- Isolate the whole house from outside the house / flat
- Isolate the whole house from inside the house / flat
- Isolate Basin hot and cold supplies
- Isolate W.C. supplies
- Isolate supplies to appliances, Dishwasher and washing machines
- Isolate hot water system
- Isolate individual showers

Being aware of these items and knowing the location and operation, before there is an issue. Will not only put your mind at ease, but ease any issues further down the line.

3) **What do I do if my pipes burst?**

Shut off the water at the main stop tap normally under the kitchen sink and open all taps to drain the system quickly. It would also be advisable to isolate the power to appliances such as the immersion heaters or shower, if you feel there is a possible risk etc.

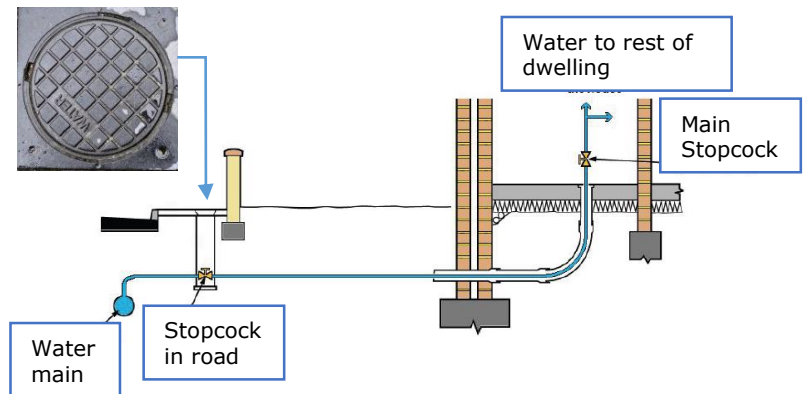

4) **How do I bleed radiators?**

A cold spot at the top of your radiator is normally due to a build-up of air in the radiator. This can usually be cured by bleeding the radiator using a key, you normally do not need to bleed every radiator, as you will find that the air will gather in the same radiators.



If the radiator is almost full of air, no difference in temperature between the top and bottom of the radiator will be felt, but in these extreme cases, the whole radiator will be cool. This will contrast with the rest of your central heating system where the other radiators will be hot to the touch.

- Have a cloth ready to catch the drips as the water is usually dirty.
- It is advised to turn your heating off and let it cool as hot water will come out of the airvent.
- If you have a sealed system you will have to check pressure and re-pressurise the system, if required.

The procedure for radiator bleeding is relatively simple and safe. A bleed valve is installed near the top of the radiator, on one side. You want to open this valve to allow a small amount of air to escape from the top of the radiator whilst not allowing the water to flow out.



TAKE CARE when turning the valve. Have a cloth ready to shield your hand and a small bowl to catch any small drops of water which may escape. You do not want dirty water dripping on the floor.



Fit the bleed key into the bleed valve and carefully turn it counter clockwise only a tiny bit, usually just a 1/4 or 1/2 turn.

The air will start escaping with a hissing sound similar to a bicycle tire. When water begins to dribble out, all the air is purged, and you can gently return the bleed valve to its previous position.

You should then remember to turn the heating back on and check that there are no leaks from the radiator bleed valve.

Check the system pressure and top up if necessary, if you are only venting a minor amount it may be fine being left.

If radiator bleeding does not seem to improve the performance of your heating, especially if several radiators in your home are malfunctioning, there may be another problem, which needs investigating.

5) **What do I do if I smell gas?**

- Do not turn electrical switches on or off. Do not use naked flames/smoke.
- Extinguish all flames and cigarettes.
- Turn off supply at the gas meter.
- Open doors and windows where possible for ventilation and go outside.
- Never tamper with gas installations.

Call us on 01865 891955 or Transco formerly British Gas, on 0800 111999. Transco deal with emergencies regardless of who supplies your gas.

Transco will come out and isolate and cap your gas supply at the meter IN ALL INSTANCES, they will not test for a leak. It is not their responsibility find and repair the leak.

6) **Should central heating be used in the summer?**

It is a good idea to run the central heating system occasionally in the summer. This is because it will help to prolong the life of certain components, such as zone valves on the heating, as these can stick in the closed position and then when you come to want the heating on they burnout and fail trying to open.

7) **My boiler is not working do I have back up for hot water?**

If you have a cylinder storing your hot water you will have an immersion heater which will provide hot water if the boiler breaks down.

8) **What is an immersion heater?**

An immersion heater is an electric water heater that sits inside a hot water cylinder. They act a bit like a kettle to heat the surrounding water. Depending on the size of your cylinder you may have one or two immersions.



Immersion heaters are connected to their own power supply via a cable. Immersion heaters are primarily used as a backup water heater (unless you have a direct cylinder).

You can turn your immersion heater on or off by simply flicking the switch on the wall socket.



A typical immersion heater uses 3 kilowatts of electricity an hour, so it will cost the average house about 30p an hour to run if running all the time, it will automatically turn off when it reaches the temperature you set on the thermostat. Most households will need to run an immersion heater for at least a couple of hours a day to get the water hot enough.

9) **What is Central Heating?**

Essentially central heating means heating from a central source. Most modern central heating systems use water as the medium to get heat from the central source (boiler) to all the areas to be heated, such as radiators and or underfloor. With central heating systems there is no such thing as a 'normal' or 'standard' system as you literally can have different combinations to suit each intended use.

A well cared for and fully functional central heating system will provide you hot water when you need it and keep your house at the required temperature.

**10) What is a condensing boiler**

All boilers we install are condensing boiler. A condensing boiler transfers much of this wasted heat (exhaust gasses) to the water in the boiler to extract further heat, before it reaches the flue outlet.

During normal operation, condensing boilers lower the temperature of their exhaust gases below 100 °C, at which point plumes of water vapour can be seen coming from the flue outside.

**11) What is a condense pipe?**

The purpose of the condensate pipe is to vent moisture from your boiler safely to the external environment. In cold weather the pipe can freeze, even if insulated. If this happens then your boiler will automatically shut down and leave you without central heating and hot water.

**12) My water is chalky?**

This can be due to the source being from underground and the large amounts of dissolved mineral salts etc. Heating this type of water converts the bicarbonates to insoluble carbonate that appears white, flaky particles. It is safe to drink

**13) My water from the tap is cloudy?**

This can be down to several factors

Air in the water, these air bubbles are much smaller than a carbonated drink and you taste no fizz. It can enter the system where the water board has carried out works down the line or when the water system is pumped. It can also be from a result in the chlorine, which is added to disinfect the water. All are safe to drink

**14) Why Do I Have Blue/Green Staining Of My Bathroom Fixtures?**

Green or blue water staining manifests itself shortly after a new plumbing system is put into continuous service and then eventually goes away. Notice of this situation occurs, and concern, generally arises, when it causes a slight blue or green discoloration in the water or, more commonly on surfaces that come in contact with the water such as baths and basins.

There are a number of processes that can cause this discoloration and staining, two of them much more common than the others. Regardless of the method the resulting discoloration occurs due to a fine dispersion of copper corrosion products in the water conveyed by the system. Elevated copper levels may be a result of either dissolved copper, particulate copper, or both. The majority of high copper level cases or "blue water" are caused by interaction between the copper tube wall and elements or compounds in the water.

It seems to occur most often when water high in bicarbonates has been allowed to stand in the piping system for some time, especially when exposed to high ambient temperatures. For instance, if a house is built and left standing while waiting for completion or occupancy during the heat of the summer months or the system has been running but no water been drawn off as not occupied. With frequent use you will find the staining ceases to occur.

**15) What is the best way to clean my bathroom suite?**

Your bathroom suite and fittings are made of durable, high quality materials. However, to ensure they keep their looks and don't scratch or tarnish, you need to be careful over your choice of cleaning fluids and materials.

Acrylic baths, basins and shower trays should be cleaned as often as possible to prevent discolouration and the build-up of deposits like lime scale.

Avoid abrasive cleaning materials at all cost; the tiny scratches they leave will dull the finish of your bathroom over time and trap dirt and deposits.

Similarly, don't use abrasive cleaners on taps and other fittings with a chrome finish to avoid scratching, flaking and corrosion.

Instead, choose a cream cleaner, applied with a soft, non-abrasive cloth. And always make sure you rinse every surface thoroughly before allowing it to dry.

**16) My wc seat hinges are rusty, how do I clean?**

Hinges should be cleaned with non-abrasive cleaning products. If you find your hinges have rusted these can be cleaned with Brasso to remove the chemical build-up. If the hinges are kept free from direct contact for long periods of chemical cleaners and are kept dry this should reduce this type of build-up in the future.

**17) My shower drips and sometimes dumps the water?**

This is due to the water left in the shower head when the shower is turned off. The atmospheric pressure holds the water in the head and over a short period of time the seal is broken by the water and the head drips or dumps from the shower head, sometimes several hours after a shower.

You could try setting your shower to a massage setting, or change the position or shake the head after a shower and see if this stops it.

**18) Why is my bath hot colder than the rest of my house?**

Under building regulations G3 which came into force in 2010, all new properties must have the temperature of the hot water supplied to the bath limited to no more than 48 °C. To do this a thermostatic blending valve is installed underneath the bath.



**19) My shower is slow to drain?**

The chances are that your shower's drainage pipe has become blocked or that there's a problem in the main drain further down. Hair tends to be the main culprit, getting trapped in the plughole and eventually clogging it completely. It may also be that soap scum and residue has combined with the hair to create a blockage or has collected over time to slow the flow of water. If the blockage is in your main drain, the causes range from leaves to a breakage in the pipe.

Most the shower trays come with hair traps. To access the trap you have to remove the grill or mushroom cover (these normally just pop off or ¼ turn), the hair trap can then be pulled or twisted out and cleaned of all the hair. You can also flush the trap with soda crystals followed by hot running water. This should clear any soap scum that may be building up.

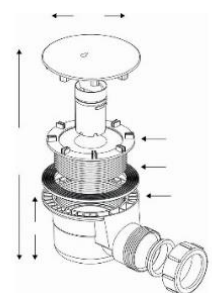



---

## 12. Disclaimer

We have tried to make this documents as helpful as possible to aid you in understanding your plumbing and heating in your property; with the advice given as useful and reliable as possible.

The purpose of this advice is to provide homeowners and landlords with general guidance and useful tips only. It doesn't necessarily deal with every important topic or cover every aspect of the topics with which it deals and might not be relevant or appropriate in all circumstances. It is not designed to provide professional advice or financial advice and should not be relied on as such.

If in any doubt, you should consult an appropriately qualified expert for specific advice before acting on any of the information contained in the document. You should never attempt to carry out any activity which may put you or others at risk or which may cause damage to your or anyone else's property.

The activities described shouldn't be attempted by anyone under the age of 18, or the inexperienced. Some activities such as those involving gas or electricity should only be carried out by qualified professionals. Always read and follow any relevant manuals and safety instructions.

To the extent permitted by law, we accept no responsibility (including loss, damage or injury) for your use of the advice in this document.